

* ALSO OFFER SOLAR PANEL HOLDERS.

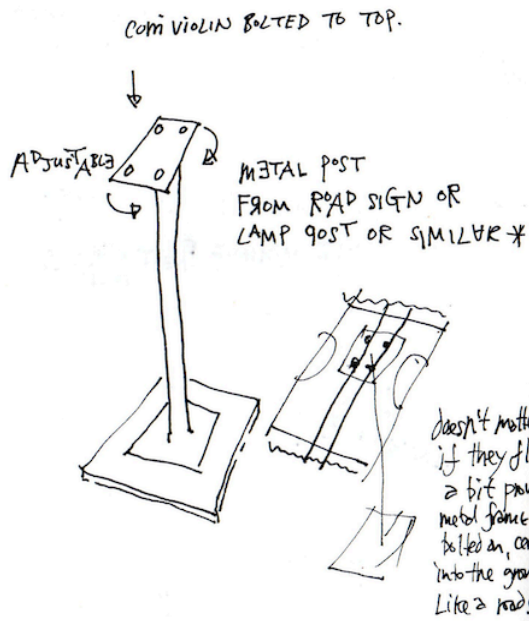

doesn't matter if they flap. a bit pointing metal frame + bolted in, cement into the ground. Like a road sign.

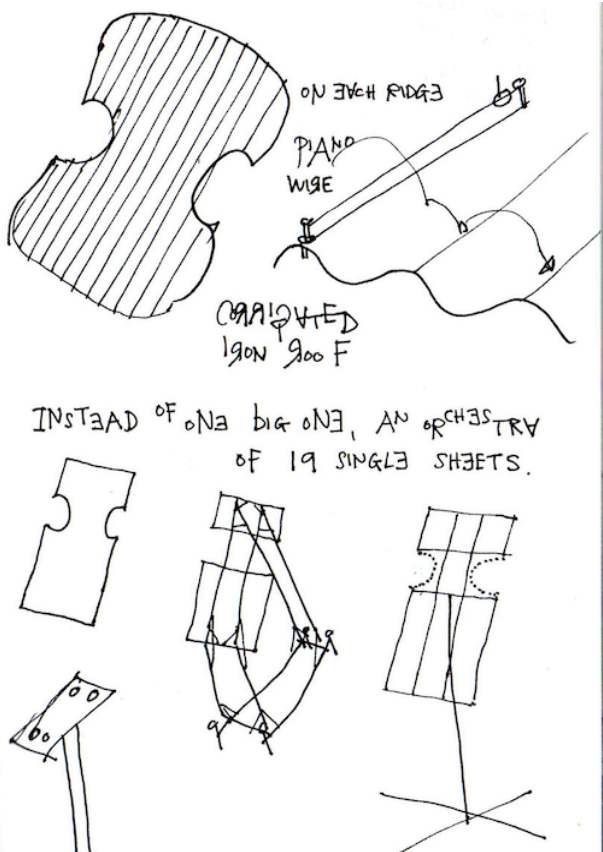

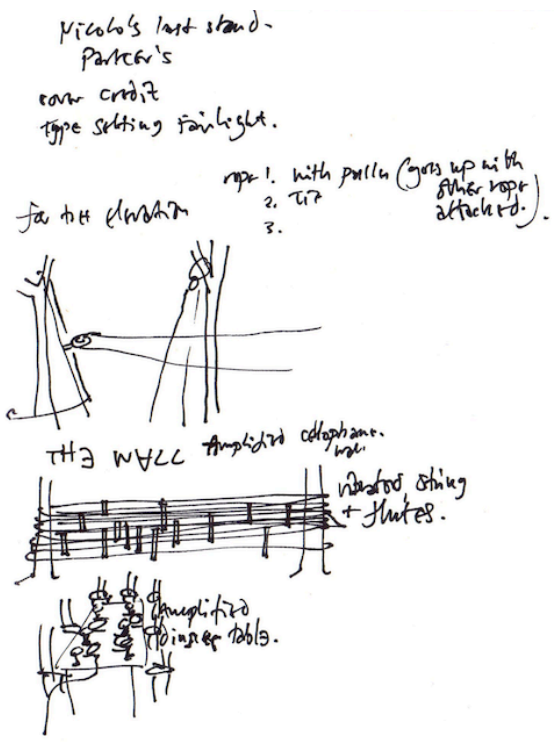
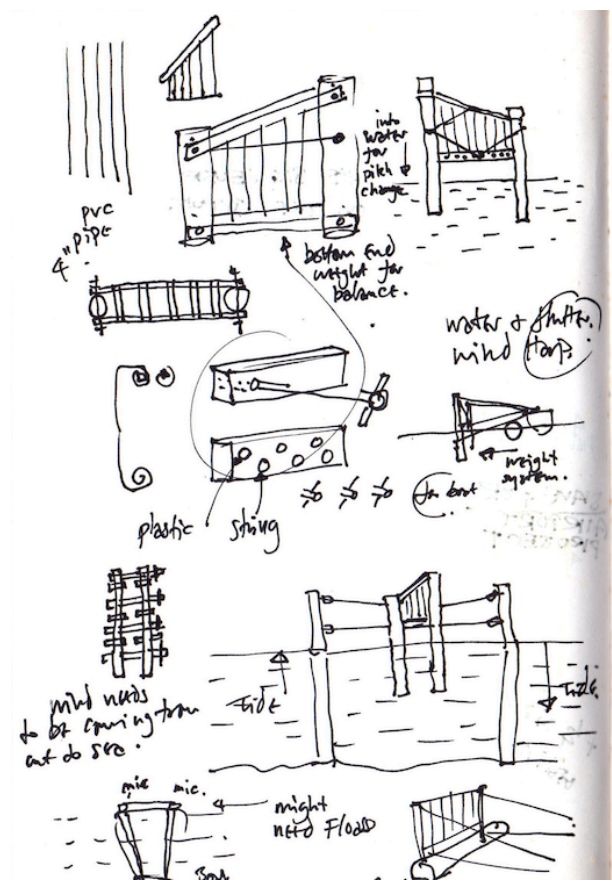
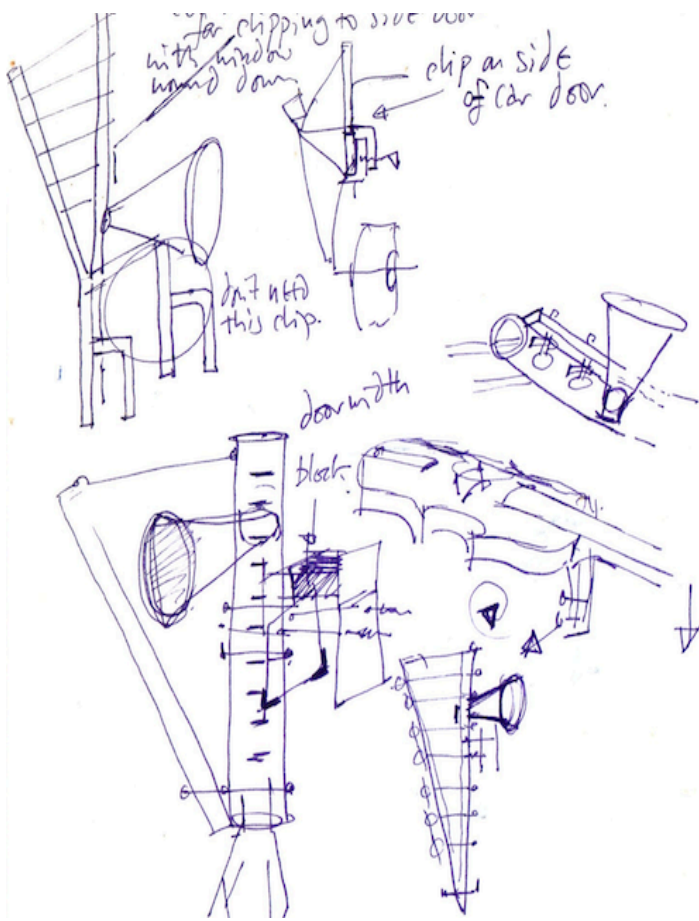
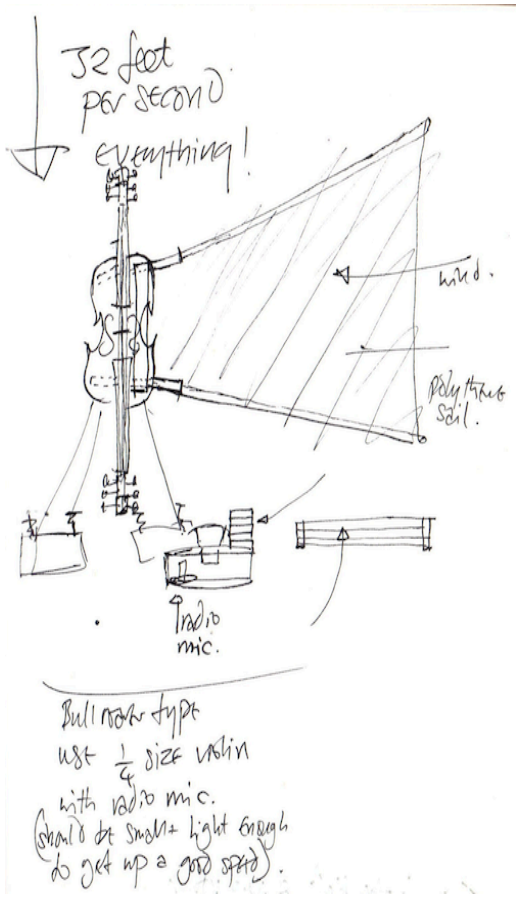

Stephen Smith
Alex
Andrew

possible fittings.
1) male bugger
2) left shoes

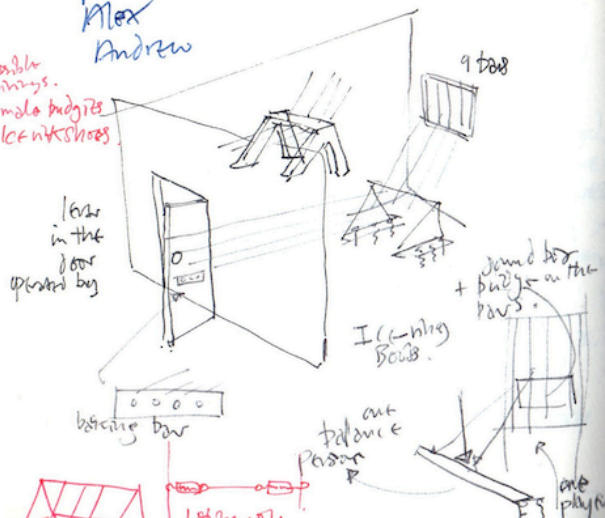

Skycycle stand for bridge.

Put ping balls + racket.

Against door or something a cross the bars.

Trevor's delay unit a couple of cassette/radio.

3 assistants.
1) can push or pull
2) by bicycle
3) in a car at speed.

Need to be able to change pitch.

owner of shop for hire of male bugger. Squash or tennis player.

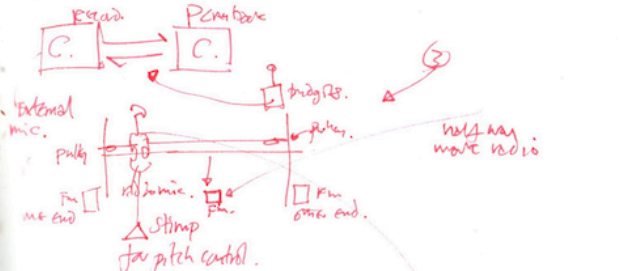

Use violin up racket. phospos. Long for separates violin against a board which can have different pitch. (Whistle!) to finish duet.

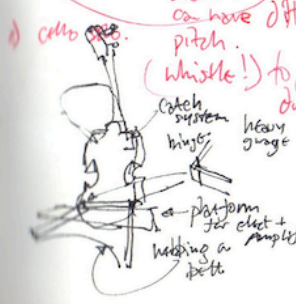

Also contact with long lead to use stinger.

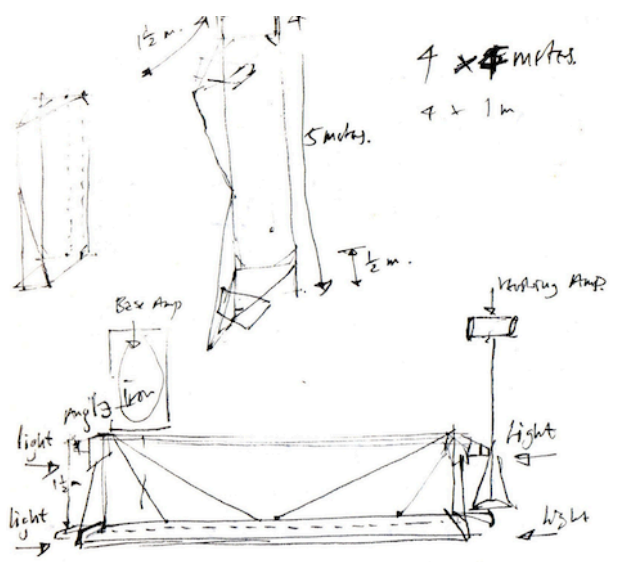
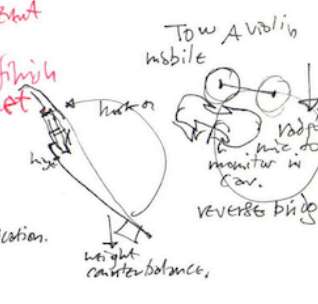

All angle frame. Bolts.

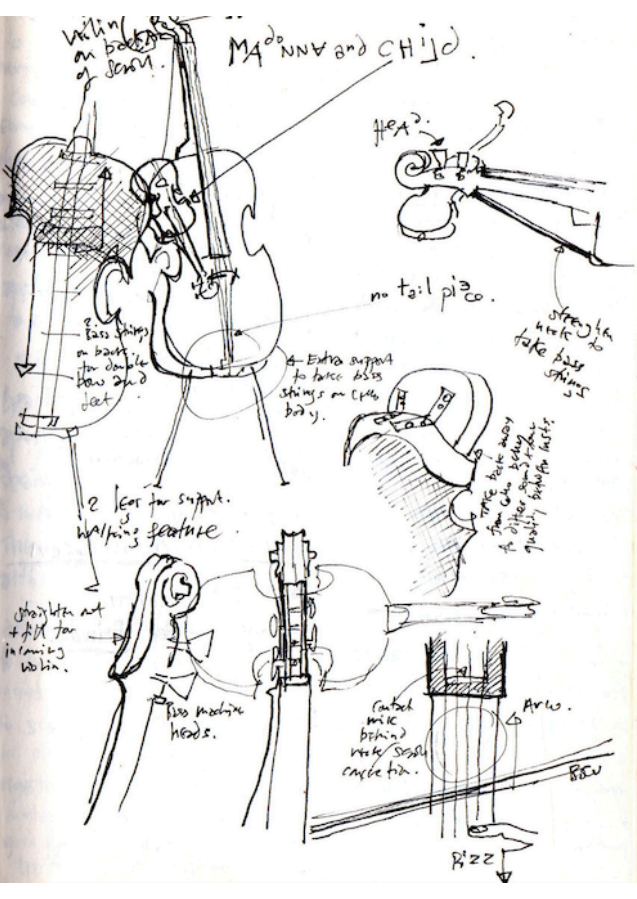
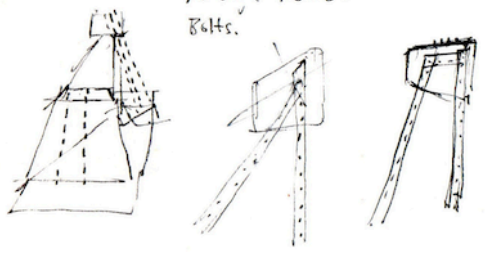

MA^{do} NUN and CHILD.

Fok Muri



next to
speakers
+ Amps.

- ③ All piano wire.
- ④ All contact mics off cello
- ⑤ Fans
- ⑥ power leads.
- ⑦ leg guards. (cricket pads) + coat the surface.



Just sort of resonator on each of the steps.

2 or 3 different violins to run up and down strings. (step ladder.)



What about ~~the~~ floor strings. old speaker box.

Six
hacksaw.
hacksaw
blades.
bolts.



3 levels

feet/pads/
chest hi.

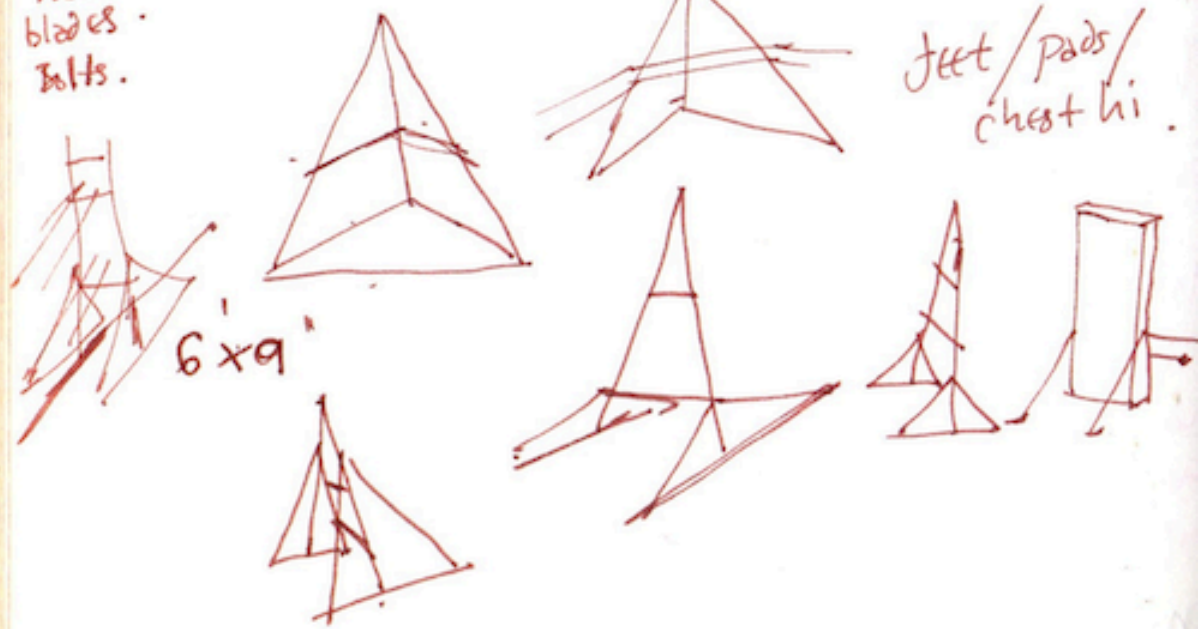

something on
 part to vibrate.
 Toy.
 of some kind.
 and back
 we interact with it.

For outside the main.
 I string
 this going all the way through out.

we use very small
 springs. come to vibrate
 string. I pump and I started
 signal through it.
 or buy strong electric motor. in # main.
 get continue to create bones or frames
 very slow movements - to fast cells

Tilt states coming in
 / a surf or delivery into
 water from a boat
 non reactive piece.

K's sculptures
 Float.

Flutter harp
 or Flutter volume?
 How to change pitch.

Resonator
 tube
 mic inside pipe
 so no wind noise.
 also body heat
 make low technique.
 play back thru vis

of course you can't play
 the violin under water
 - it needs air!
 submerging the resonator
 (while leaving strings above)
 is good phrasing value though.

the perfect
 sailor -
 very good
 stability and
 lies horizontally
 Perfect

Scott Lyndhurst.
 James Heller
 carved

in a low
 surf?

small would be
 most effective.

10,000
 8,000
 1,000 - 5 concavities
 6

violin
 Jet propelled violin collision.

in vision
 out of sight →

Cancel
 The real McCoy
 Tromba
 Making!!

8'
 player plays
 thru the
 6 hour tide
 cycle.

From the top.
 Symphony no 1.
 by God.
 Dog pianist.

could use the
 pipe as an
 alternative body

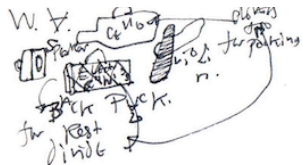

- 2 vol ped
- amps load
- speaker
- 2 extra external mics
- 4 leads
- 2 preamps
- cello
- violin
- radio mic
- cheap mic.

Box of cassette
 + 2 mics + enough P.A.
 to put on a couple of gigs in both.

A few tools, oh, etc
 spare strings

Various mechanisms.
 For P.A. next spring
 Inst ALL + 70%

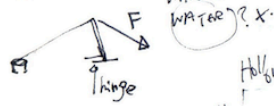

1 hour prod. U.
 1 hour prod. C.
 Radiology - Questionnaire
 church organ concert - Maxonthon.

9000
 impact in P.A. next
 spring into U.S. ship
 coming to port.

Political
 in 9 R. U.S. ...
 with a ...

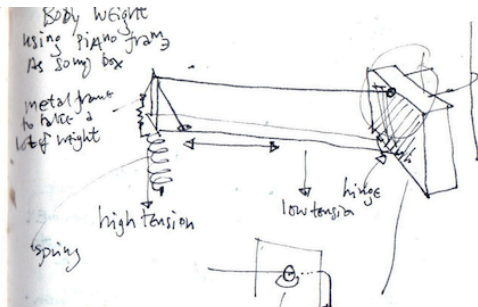

THE virgin's REACTIVE

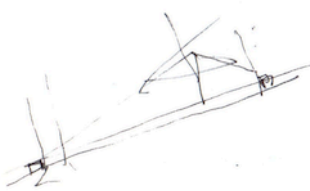
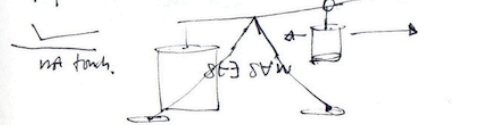
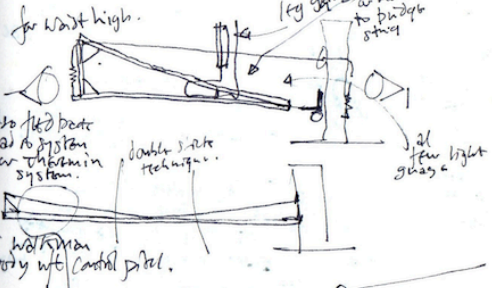

reading
 cut P.A. out
 of K. B. concert.
 Just make mod + chi.

Installation is
 just a out string

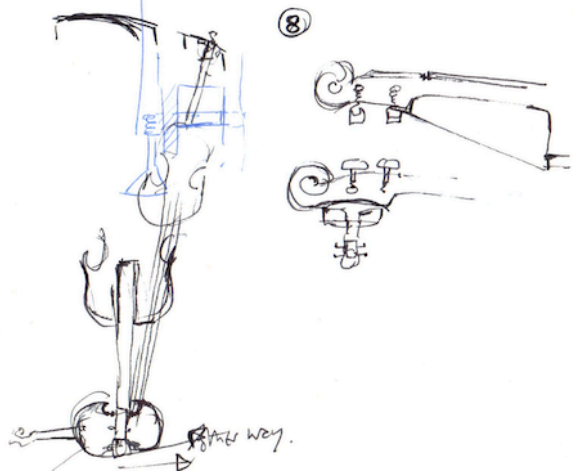
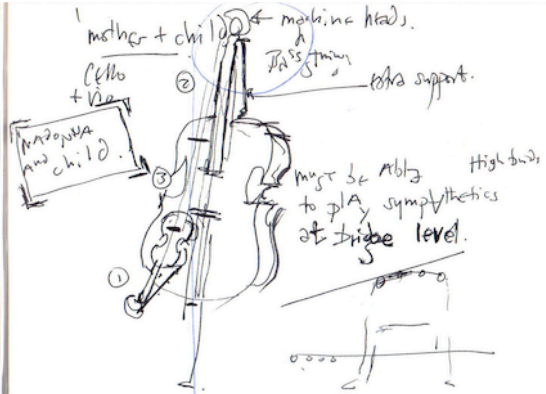

TRIG FLUTE VIOLA. MECHAN. VIBRO.
 Pream. René's dream. Castle Ford wall over potaculis
 violin plays. amplified

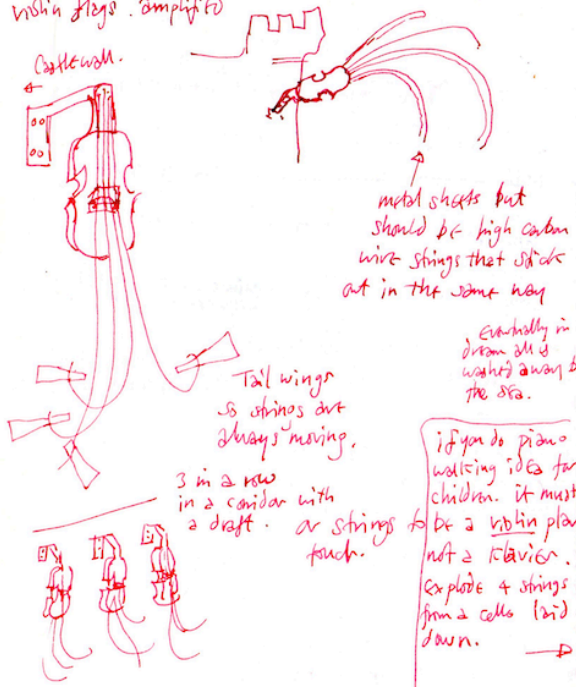

metal sheets but
 should be high carbon
 wire strings that stick
 out in the same way

Eventually in
 dream all is
 washed away by
 the sea.

if you do piano
 walking idea for
 children. it must
 be a violin plan
 not a clavich.
 explode 4 strings
 from a cello (vi)
 down.

3 in a row
 in a cavitar with
 a draft. or strings
 touch.

Sensitive- conversation
 with lots of gaps over
 the piano in the black tape.
 talking about 'vibes' - from through
 ribs & piano!

REC VIOLIN IDEA

CELLO MIT JOELLS?
 6 single bar stuff with ribs
 8 form. [1 1 1 1]

then to Turkish folk chant by
 kids recited in the park by Brittanien.

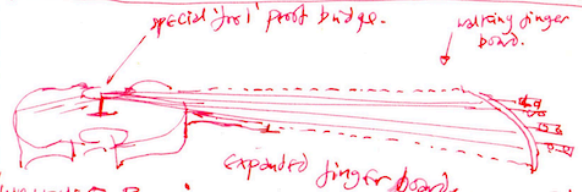

Bergini

Chant.
 all literary
 Texts.
 in 5ths.

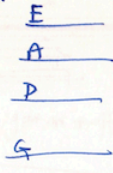

might have to change punctuation
 and put it in all one piece.

pitch shift any singing
 to 2 octaves high
 + low - take out middle
 out.

from pulpit - all as if a sermon.
 whisper as if in side his head

Pedal board.

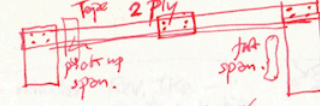

8 short nuts
 + bolts.



3 nuts
 + washers x 4
 2 nuts + bolts x 2.



pick up. side on.

into 500p preamp
 Amp

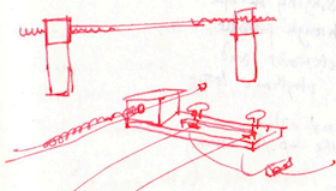

nuts are
 placed on
 the pulley.